

GYMSTICK™

GYMSTICK WEIGHT BENCH 30 WITH 40 KG BARBELL SET (STR-WB40)



OWNER'S MANUAL (ENGLISH)

INDEX

SAFETY INSTRUCTIONS	page 1
HARDWARE LIST	page 2-3
ASSEMBLY STEPS	page 4-19
EXPLODED DRAWING	page 20
PARTS LIST	page 21
IMPLIED WARRANTY	page 22

SAFETY INSTRUCTIONS

WARNING

To reduce the risk of serious injury, read the following safety instructions before using the EVERLAST POWER TRAINING BENCH

IMPORTANT : THIS UNIT IS INTENDED FOR HOUSEHOLD USE ONLY

1. Use the EVERLAST POWER TRAINING BENCH only on a level surface.
2. Keep children and pets away from this equipment at all times.
3. The EVERLAST POWER TRAINING BENCH should not be used by persons weighing more than 110Kgs
4. The EVERLAST POWER TRAINING BENCH should be used by only one person at a time.
5. Be careful to maintain your balance while using, mounting, dismounting, folding, unfolding or assembling the EVERLAST POWER TRAINING BENCH Loss of balance may result in a fall and serious bodily injury
6. Use the EVERLAST POWER TRAINING BENCH only as described in the manual.
7. Do not attempt to adjust the back rest while you are on the bench.
8. Before using this equipment to exercise, always do stretching exercises to properly warm up.
9. Always make sure all bolts and nuts are tightened prior to each use.
10. If dizziness, nausea, chest pains, or any other abnormal symptoms are experienced while using this equipment, STOP the workout at once. CONSULT A PHYSICIAN IMMEDIATELY











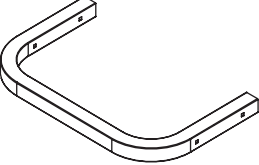

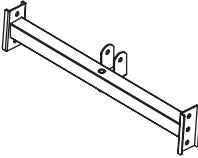
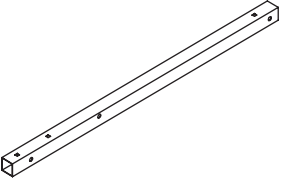
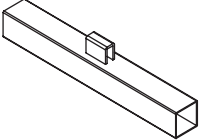

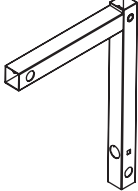
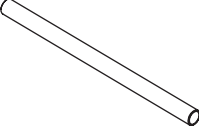
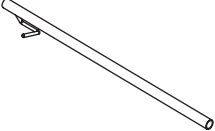

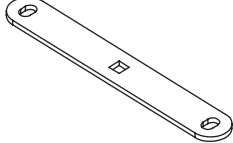
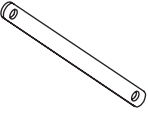
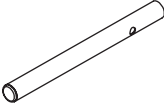
WARNING

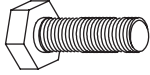
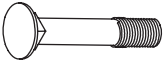
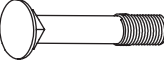
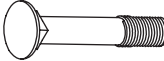







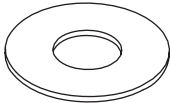
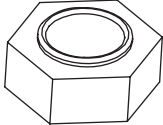
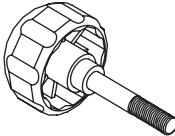
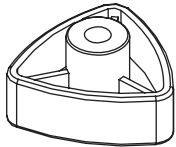
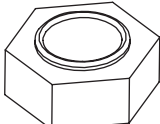
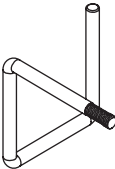
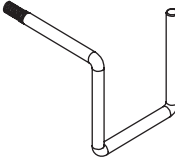
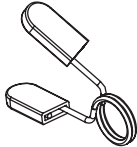

Before starting any exercise or conditioning program you should consult with your personal physician to see if you require a complete physical exam.

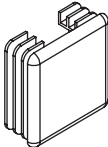
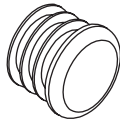
This is especially important if you are over the age of 35, have never exercised before, are pregnant or suffer from any illness.

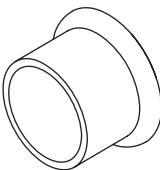
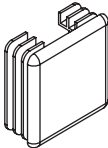
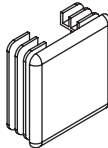
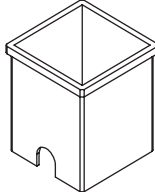
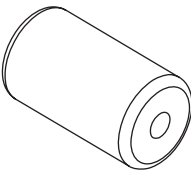
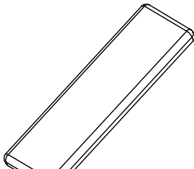
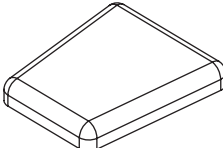
HARDWARE LIST

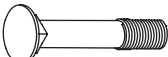
 <p>WB40-01 Rear Stabilizer 1pc</p>	 <p>WB40-02 Upright 2pcs</p>	 <p>WB40-03 Cross Support 1pc</p>	 <p>WB40-04 Main Frame 1pc</p>
 <p>WB40-05 Front Stabilizer 1pc</p>	 <p>WB40-06 Leg Extension Upright 1pc</p>	 <p>WB40-07 Leg Extension Support 1pc</p>	 <p>WB40-08 Leg Extension 1pc</p>
 <p>WB40-09 Foam Roller Post 3pcs</p>	 <p>WB40-10 Backrest Adjustment Rod 1pc</p>	 <p>WB40-11 Backrest Support 2pcs</p>	 <p>WB40-12 Seat Backrest 1pc</p>
 <p>WB40-13 Stabilizer Bracket 2pcs</p>	 <p>WB40-14 Weight Disc Post 1pc</p>	 <p>WB40-15 Bolt (M6 x 14mm) 2pcs</p>	 <p>WB40-16 Bolt (M6 x 40mm) 4pcs</p>
 <p>WB40-17 Carriage Bolt (M8 x 50mm) 8pcs</p>	 <p>WB40-18 Carriage Bolt (M8 x 55mm) 1pc</p>	 <p>WB40-19 Carriage Bolt (M8 x 90mm) 1pc</p>	 <p>WB40-20 Hex Bolt (M10 x 60mm) 1pc</p>
 <p>WB40-21 Hex Bolt (M10 x 130mm) 1pc</p>	 <p>WB40-22 Flat Washer (M6) 6pcs</p>	 <p>WB40-23 Flat Washer (M8) 15pcs</p>	 <p>WB40-24 Spring Washer (M8) 2pcs</p>

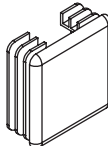
HARDWARE LIST

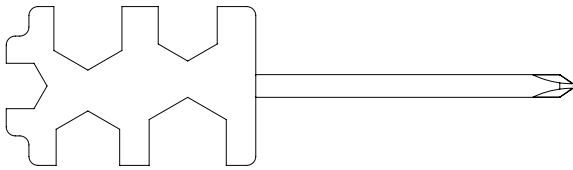

 <p>WB40-25 Flat Washer (M10) 8pcs</p>	 <p>WB40-26 Nylon Locknut (M8) 13pcs</p>	 <p>WB40-27 Locking Knob (Male M8) 1pc</p>	 <p>WB40-28 Locking Knob (Female M8) 2pcs</p>
 <p>WB40-29 Nylon Locknut (M10) 4pcs</p>	 <p>WB40-30L Safety Hook (Left side) 1pc</p>	 <p>WB40-30R Safety Hook (Right Side) 1pc</p>	 <p>WB40-31 Spring Collar 1pc</p>
 <p>WB40-32 Backrest Support Bushing 2pcs</p>	 <p>WB40-33 Square End Cap (25mm) 4pcs</p>	 <p>WB40-34 Round End Cap (ø19mm) 8pcs</p>	 <p>WB40-35 Round End Cap (ø25mm) 1pc</p>
 <p>WB40-36 Round End Over Cap (ø25mm) 1pc</p>	 <p>WB40-37 Square End Cap (32mm) 2pcs</p>	 <p>WB40-38 Square End Cap (38mm) 6pcs</p>	 <p>WB40-39 Square Internal Bushing (38mm) 1pc</p>
 <p>WB40-40 Foam Roller 6pcs</p>	 <p>WB40-41 Backrest 1pc</p>	 <p>WB40-42 Sest 1pc</p>	 <p>WB40-43 Hex Bolt (M10 x 55mm) 2pcs</p>
 <p>WB40-44 Carriage Bolt (M8 x 85mm) 2pcs</p>	 <p>WB40-45 Carriage Bolt (M8 x 45mm) 3pcs</p>	 <p>WB40-46 Square End Cap (33.4mm) 5pcs</p>	 <p>WB40-47 Locknut (M6) 2pcs</p>
 <p>WB40-48 Washer (M6) 2pcs</p>	 <p>WB40-49 Tool 2pcs</p>		

ASSEMBLY STEPS

COMPLETE EACH STAGE IN ORDER BEFORE ADVANCING ON TO THE NEXT.
 ASSEMBLE WITH NUTS AND BOLTS LOOSE AT FIRST.
 TIGHTEN ALL BOLTS AND NUTS AFTER COMPLETING ALL ASSEMBLY STEPS.

STEP 1

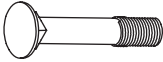
- Connect both **Uprights** (2) to the **Cross Support** (3) using four M8 x 50mm **Carriage Bolts** (17) fitted from the inside as per illustration, four M8 **Flat Washers** (23) and four M8 **Nylock Nuts** (26).

No.	Description	Q'ty
WB40-17	 Carriage Bolt (M8 x 50mm)	4
WB40-23	 Flat Washer (M8)	4
WB40-26	 Nylock Nut (M8)	4



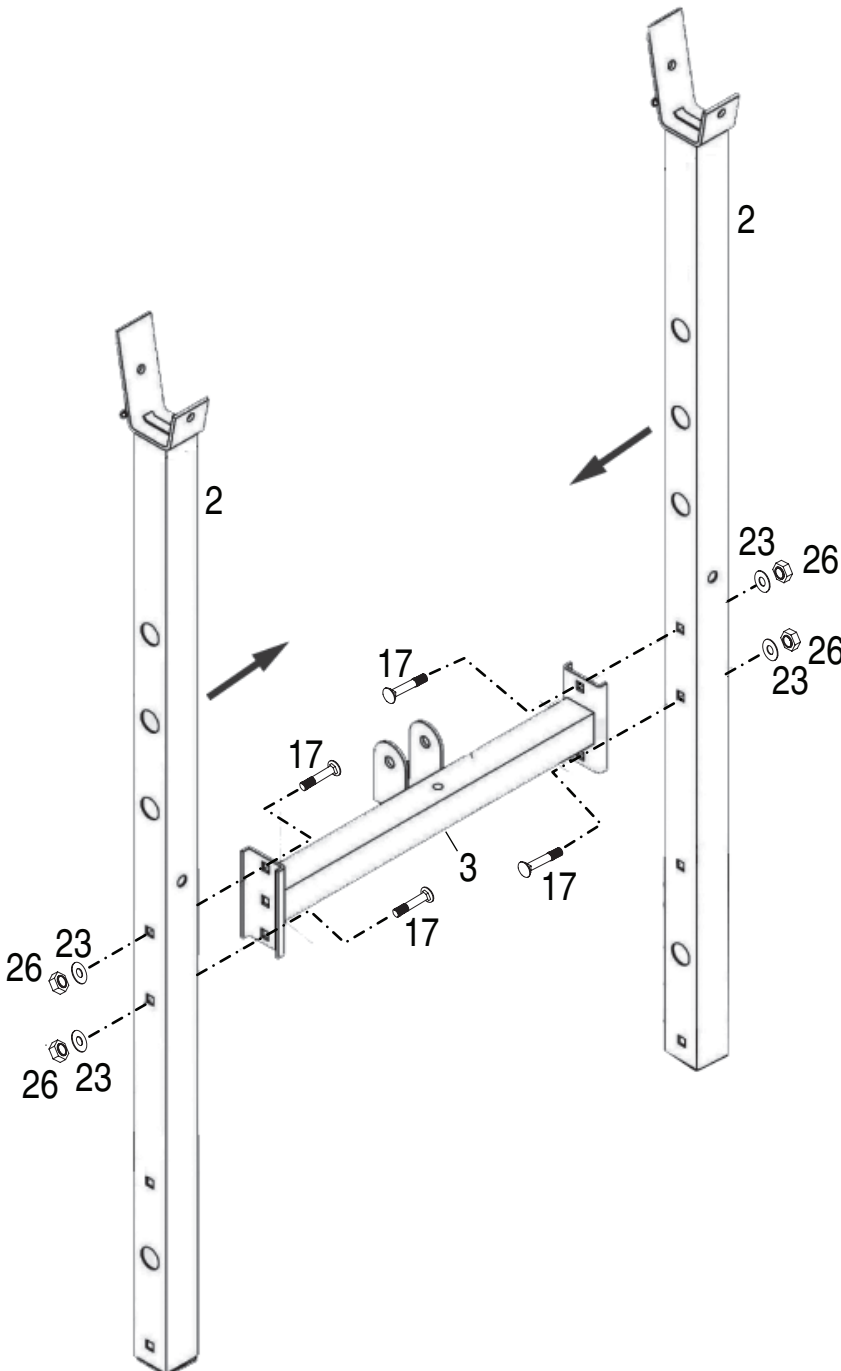

ASSEMBLY STEPS



ASSEMBLY STEPS

STEP 2

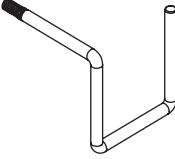
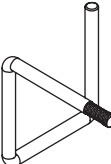
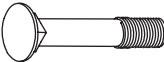
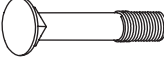
- Place both **Uprights** (2) on the inside of the **Rear Stabilizer** (1) and secure in place using M8x85mm **Carriage Bolts** (44) fitted from the outside, M8 **Flat Washers** (23) and M8 **Nylock Nuts** (26).
- Now attach both **Stabilizer Brackets** (13) to the inside of the **Rear Stabilizer** (1) and to the outside of both **Uprights** (2) using M8x50mm **Carriage Bolts** (17), and M8x45mm **Carriage Bolts** (45), four M8 **Flat Washers** (23) and four M8 **Nylock Nuts** (26).
- Attach the **Safety Hook** (30L & 30R) to the both **Uprights** (2). Using two **Washers** (48) and two **Nylock Nuts** (47). As shown.

No.	Description	Q'ty
WB40-17	 Carriage Bolt (M8 x 50mm)	2
WB40-23	 Flat Washer (M8)	6
WB40-26	 Nylock Nut (M8)	6
WB40-30R	 Safety Hook	1
WB40-30L	 Safety Hook	1
WB40-44	 Carriage Bolt (M8 x 85mm)	2
WB40-45	 Carriage Bolt (M8x45mm)	2
WB40-47	 Nylock Nut (M6)	2
WB40-48	 Washer (M6)	2



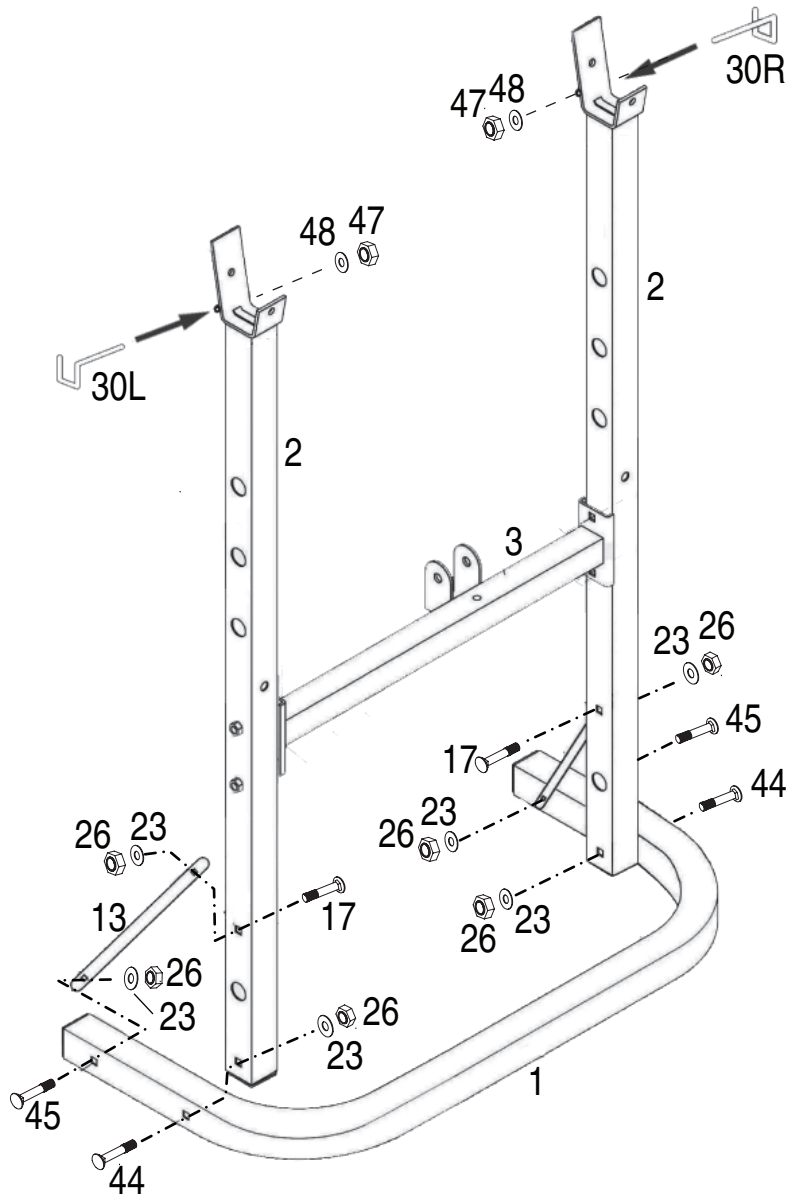

ASSEMBLY STEPS

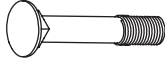

ASSEMBLY STEPS

STEP 3

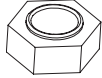
- Fit the **Front Stabiliser** (5) to the **Leg Extension Upright** (6) and secure with an M8x50mm **Carriage Bolt** (17), an M8 **Flat Washer** (23) and an M8 **Nylock Nut** (26).
- Connect the assembled **Leg Extension Upright** (6) to the front of the **Main Frame** (4) using an M10x55mm **Hex Head Bolt** (43), two M10 **Flat Washers** (25) and an M10 **Nylock Nut** (29) bolted from the side.

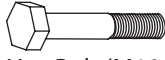
No.	Description	Q'ty
WB40-17	 Carriage Bolt (M8 x 50mm)	1
WB40-23	 Flat Washer (M8)	1
WB40-25	 Flat Washer (M10)	2
WB40-26	 Nylock Nut (M8)	1
WB40-29	 Nylock Nut (M10)	1
WB40-43	 Hex Bolt (M10 x 55mm)	1

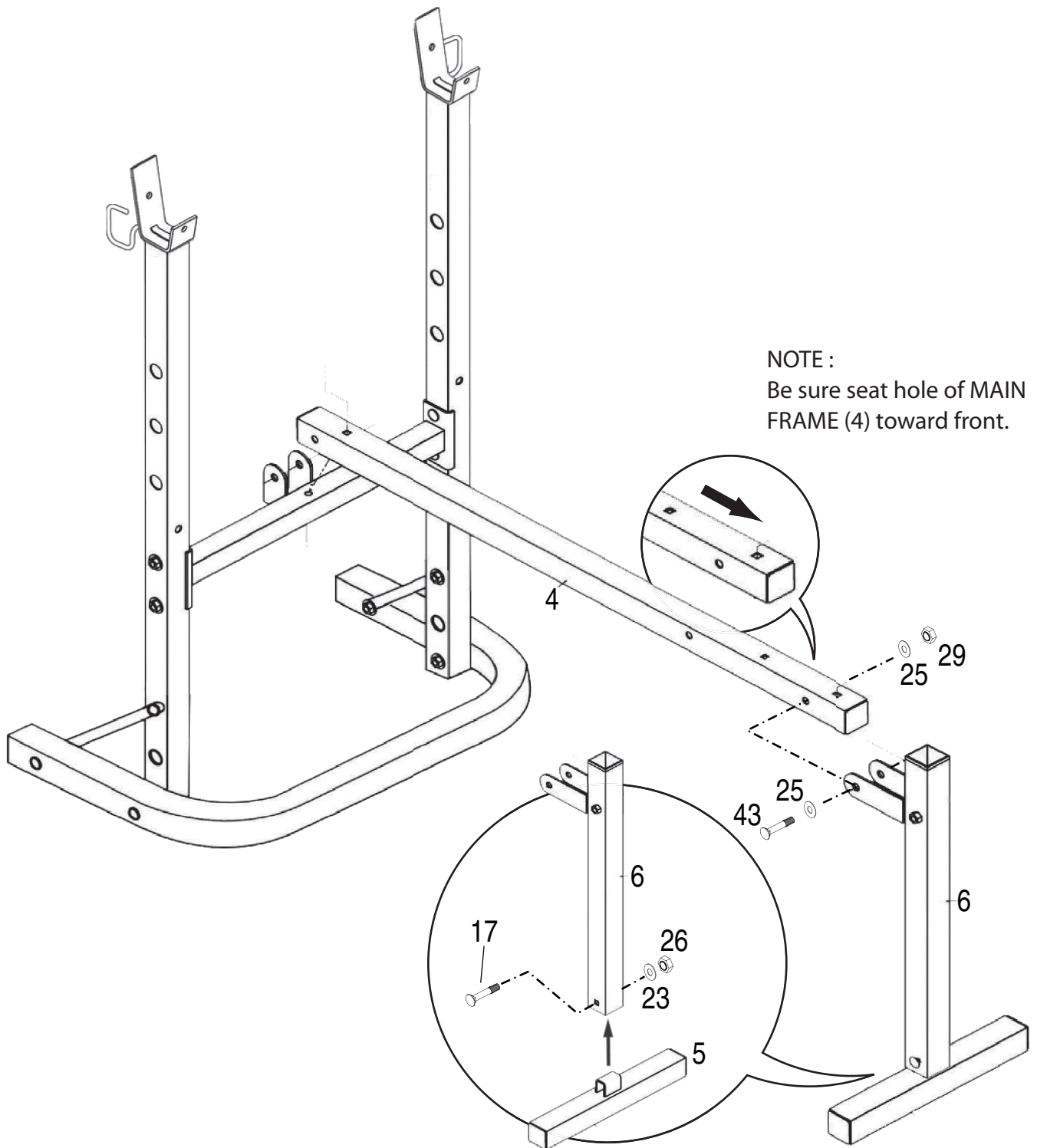

ASSEMBLY STEPS



ASSEMBLY STEPS

STEP 4

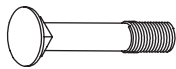
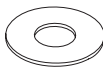
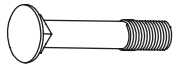
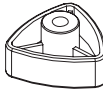
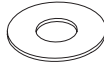
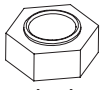
- Place an M8x55mm **Carriage Bolt** (18) in the UPPER hole and secure in position using an M8 **Flat Washer** (23), an M8 **Spring Washer** (24) and an M8 **Locking Knob** (Female) (28). Tighten securely to lock the frame in position.
- Connect the rear of the **Main Frame** (4) to the **Cross Bar** (3) using an M10x55mm **Hex Head Bolt** (43), two M10 **Flat Washers** (25) and an M10 **Nylock Nut** (29) bolted from the side.
- Place an M8x90mm **Carriage Bolt** (19) in the upper hole and secure in position using an M8 **Flat Washer** (23), an M8 **Spring Washer** (24) and M8 **Locking Knob** (Female) (28). Tighten securely to lock the **Main Frame** (4) in position.

No.	Description	Q'ty	No.	Description	Q'ty
WB40-18	 Carriage Bolt (M8 x 55mm)	1	WB40-25	 Flat Washer (M10)	2
WB40-19	 Carriage Bolt (M8 x 90mm)	1	WB40-28	 Locking Knob (Female M8)	2
WB40-23	 Flat Washer (M8)	2	WB40-29	 Nylock Nut (M10)	1
WB40-24	 Spring Washer (M8)	2	WB40-43	 Hex Bolt (M10 x 55mm)	1

ASSEMBLY STEPS

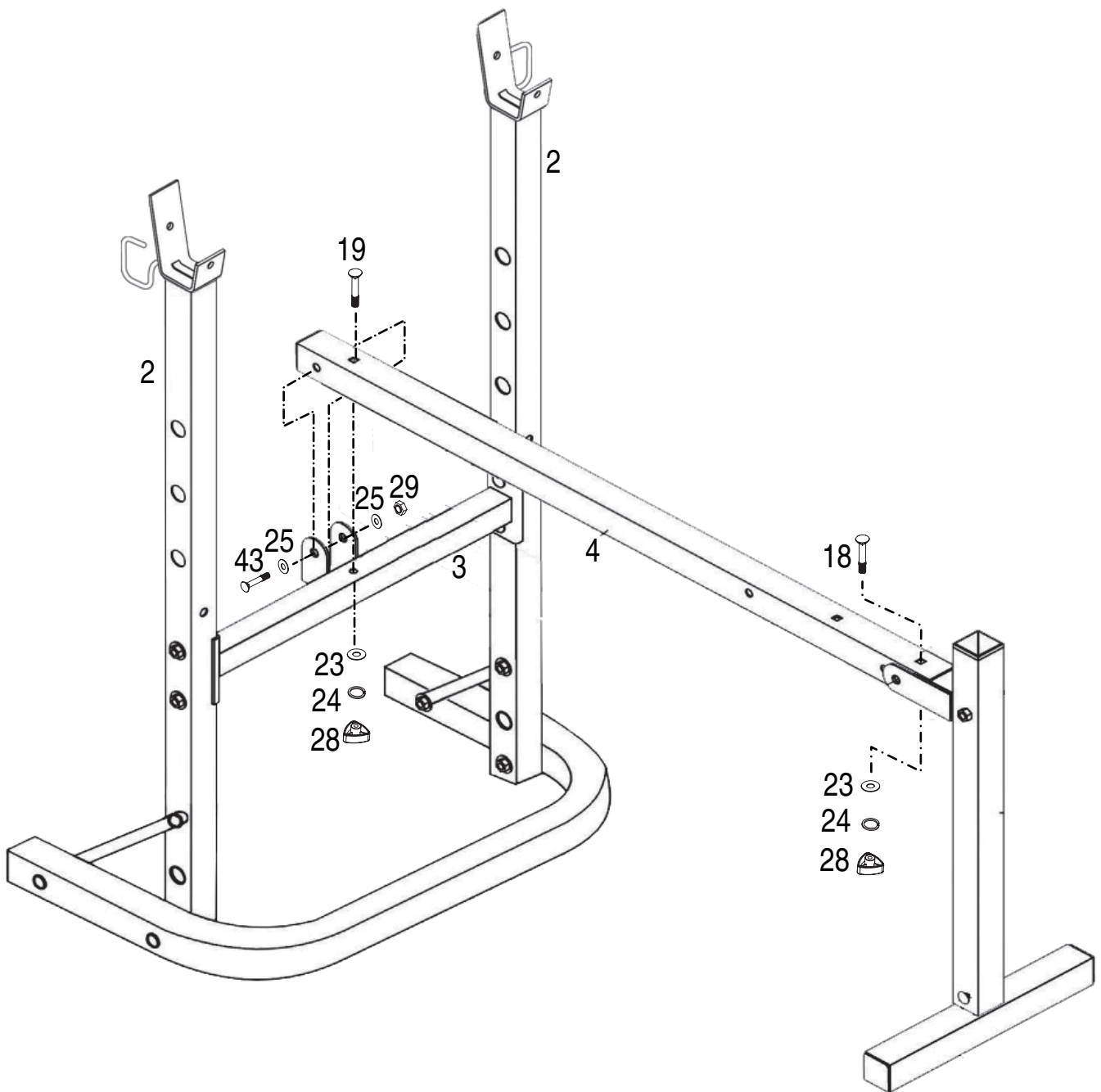

ASSEMBLY STEPS

STEP 5

- Fit the **Backrest Supports** (11) to the **Backrest** (41) using four M6x40mm **Bolts** (16) and four M6 **Flat Washers** (22).

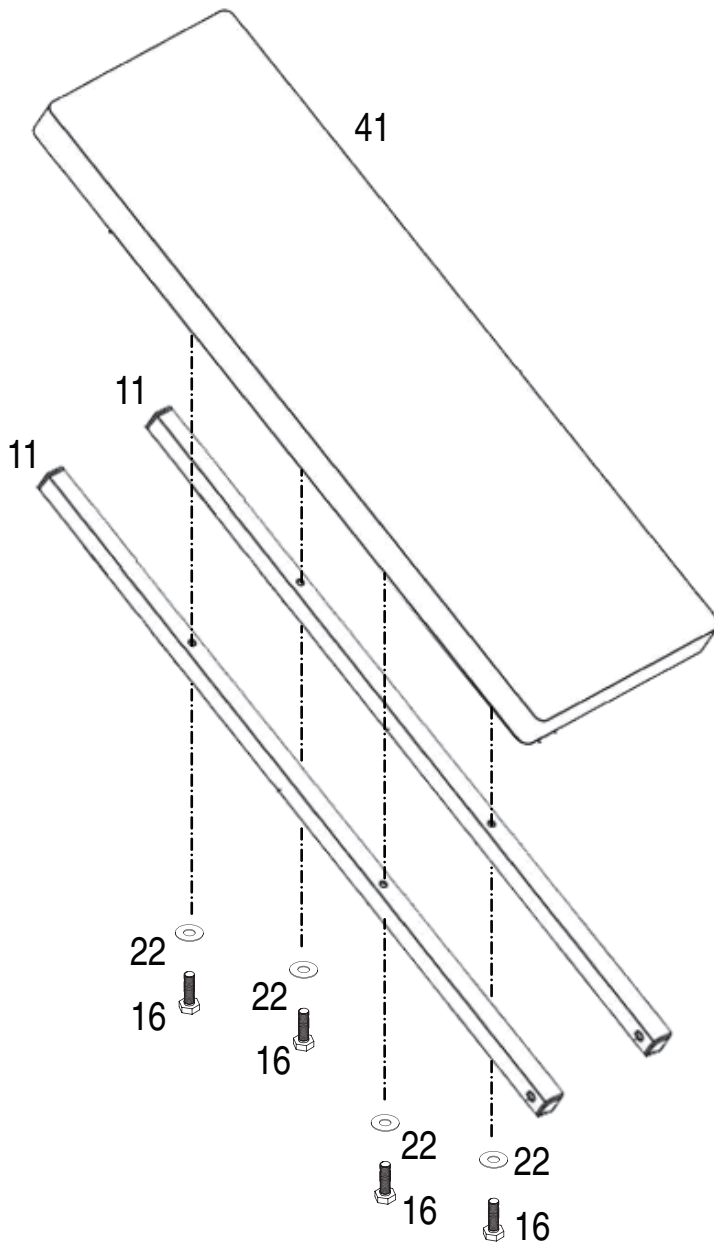

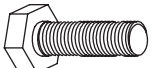
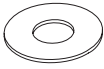

No.	Description	Q'ty
WB40-16	 Bolt (M6 x 40mm)	4
WB40-22	 Flat Washer (M6)	4

ASSEMBLY STEPS

STEP 6

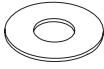
- Connect the assembled **Backrest** (41) to the **Main Frame** (4) using the fittings in the following sequence. An M10x130mm **Hex Bolt** (21), an M10 **Flat Washer** (25) and an **Backrest Support Bushing** (32) on one side then an **Backrest Support Bushing** (32) on the other side of **Main Frame** (4), an M10 **Flat Washer** (25) and an M10 **Nylock Nut** (29). Tighten securely to remove all free-play but take care NOT to overtighten.
- Insert **Backrest Adjustment Rod** (10) to assembled **Upright** (2).



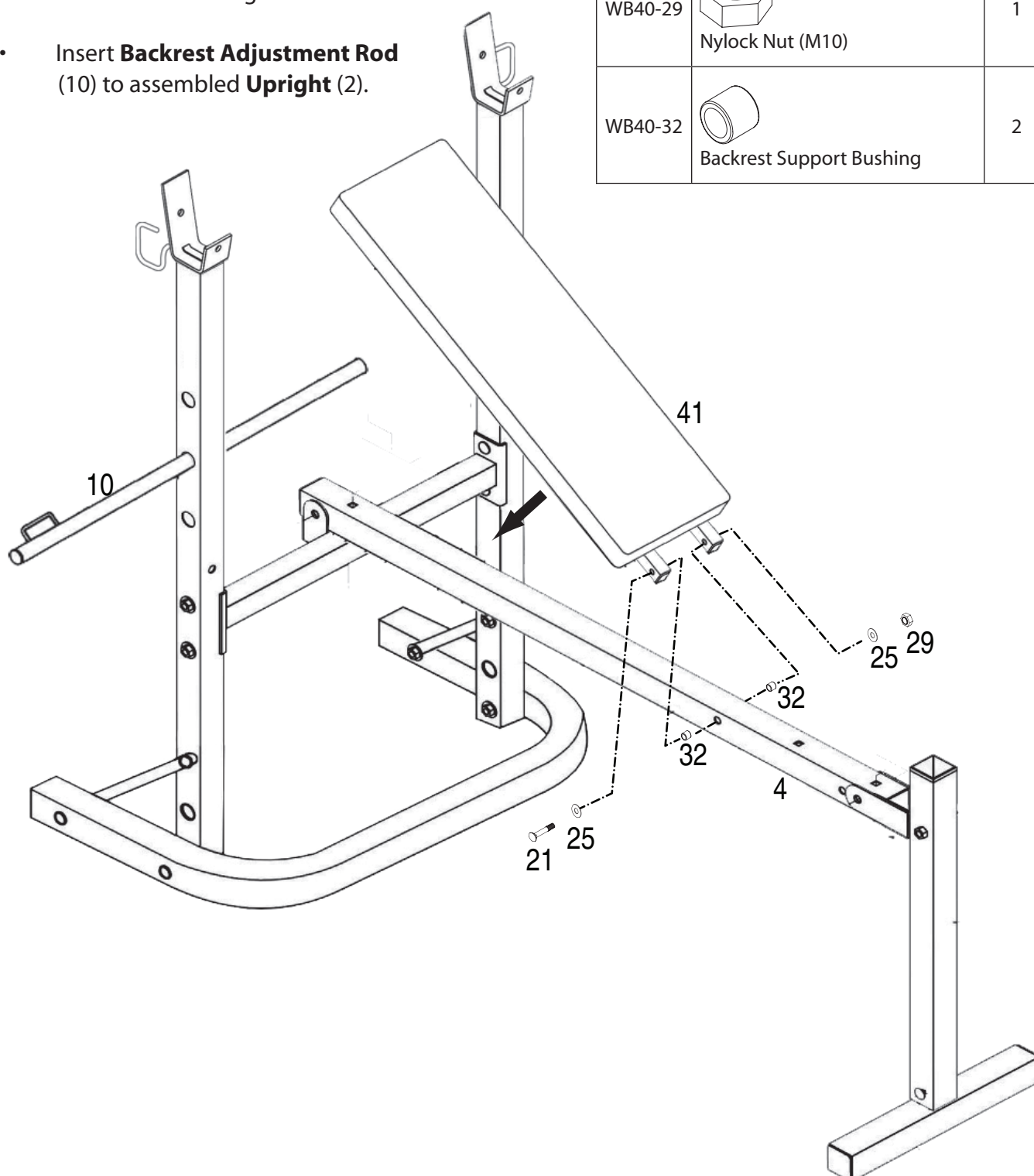

No.	Description	Q'ty
WB40-21	 Hex Bolt (M10 x 130mm)	1
WB40-25	 Flat Washer (M10)	2
WB40-29	 Nylock Nut (M10)	1
WB40-32	 Backrest Support Bushing	2

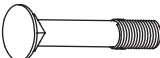

ASSEMBLY STEPS

STEP 7

- Remove the pre-fitted **Seat Bracket** (12) from the **Seat** (42). Fit the **Seat Bracket** (12) to the **Main Frame** using an M8 x 50mm Carriage Bolt (17). An M8 **Flat Washer** (23) and an M8 **Nylock Nut** (26) tightening securely.
- Fit the **Seat** (42) to this **Seat Bracket** (12) using the previously removed two M6x14mm **Bolts** (15) and two M6 **Flat Washers** (22).
- The Backrest can be adjusted into 4 positions for convenient use. (Flat and 3 Incline Positions). Please ensure that **Backrest Adjustment Rod** (10) is positioned UNDER the Backrest Supports and is secured into place in any one of the 3 adjustment holes in the Uprights before use.

No.	Description	Q'ty
WB40-15	 Bolt (M6 x 14mm)	2
WB40-17	 Carriage Bolt (M8 x 50mm)	1
WB40-22	 Flat Washer (M6)	2
WB40-23	 Flat Washer (M8)	1
WB40-26	 Nylock Nut (M8)	1



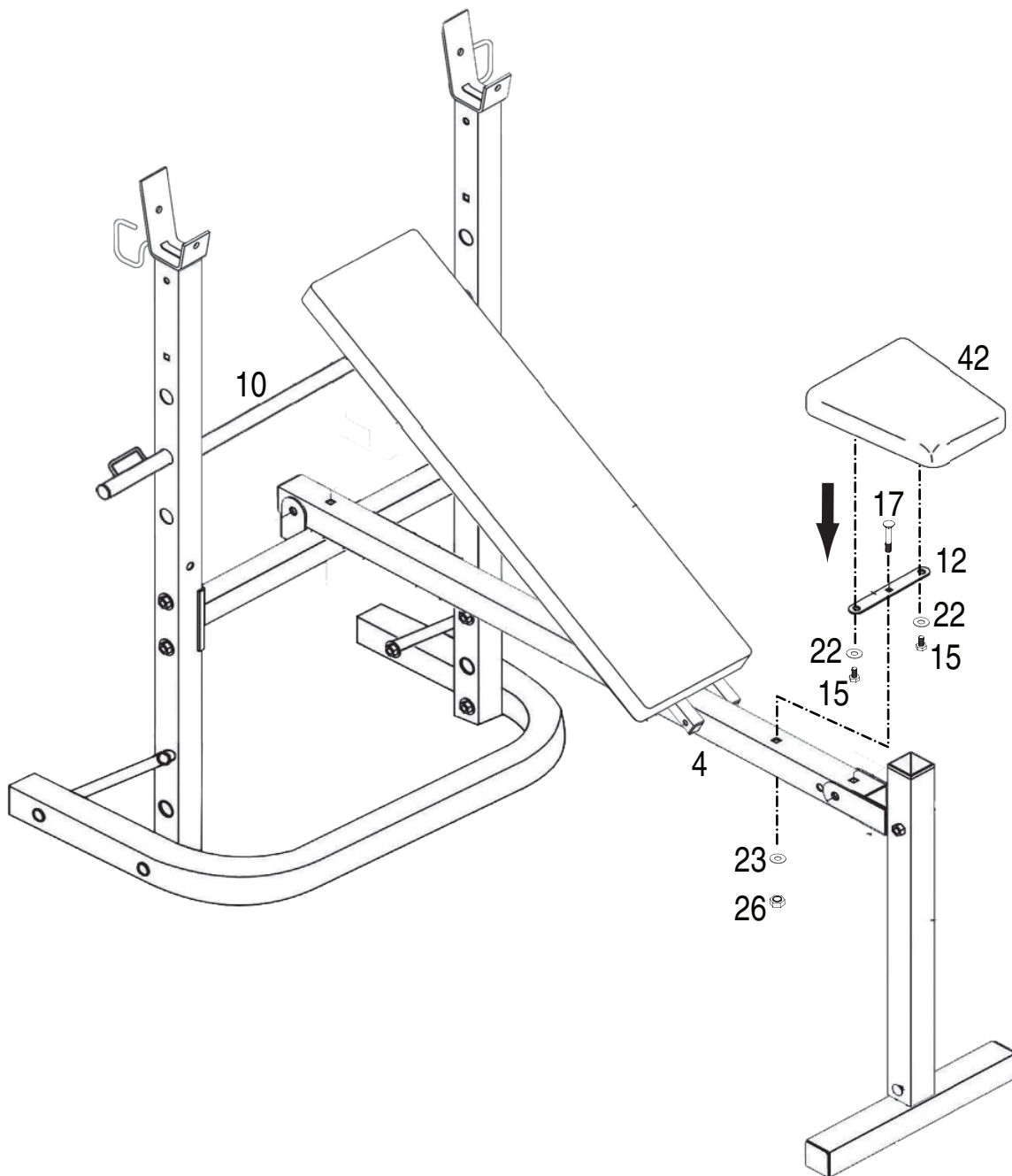



ASSEMBLY STEPS

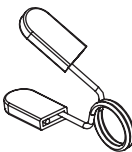

ASSEMBLY STEPS

STEP 8

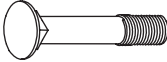
- Assemble the **Leg Extension** (8) to the **Leg Extension Support** (7) using an M10x60mm **Hex Bolt** (20), two M10 **Flat Washers** (25) and an M10 **Nylock Nut** (29) bolted from the side.
- Fit the **Leg Extension Weight Disc Post** (14) to the Leg Extension using an M8x48mm **Carriage Bolt** (45), an M8 **Flat Washer** (23) and an M8 **Nylock Nut** (26). Tighten securely and fit **Spring Collar** (31) by squeezing the 2 rubber pads together and sliding over end of **Weight Disc Post** (14).
- Slide a **Foam Roller** (40) onto one end of a **Foam Roller Post** (9) and fit into position on the **Leg Extension** (8) and **Leg Extension Support** (7). Slide the remaining **Foam Roller** (40) onto the **Foam Roller Post** (9).

No.	Description	Q'ty	No.	Description	Q'ty
WB40-20	 Hex Bolt (M10 x 60mm)	1	WB40-29	 Nylock Nut (M10)	1
WB40-23	 Flat Washer (M8)	1	WB40-31	 Spring Collar	1
WB40-25	 Flat Washer (M10)	2	WB40-45	 Carriage Bolt (M8 x 45mm)	1
WB40-26	 Nylock Nut (M8)	1			

ASSEMBLY STEPS

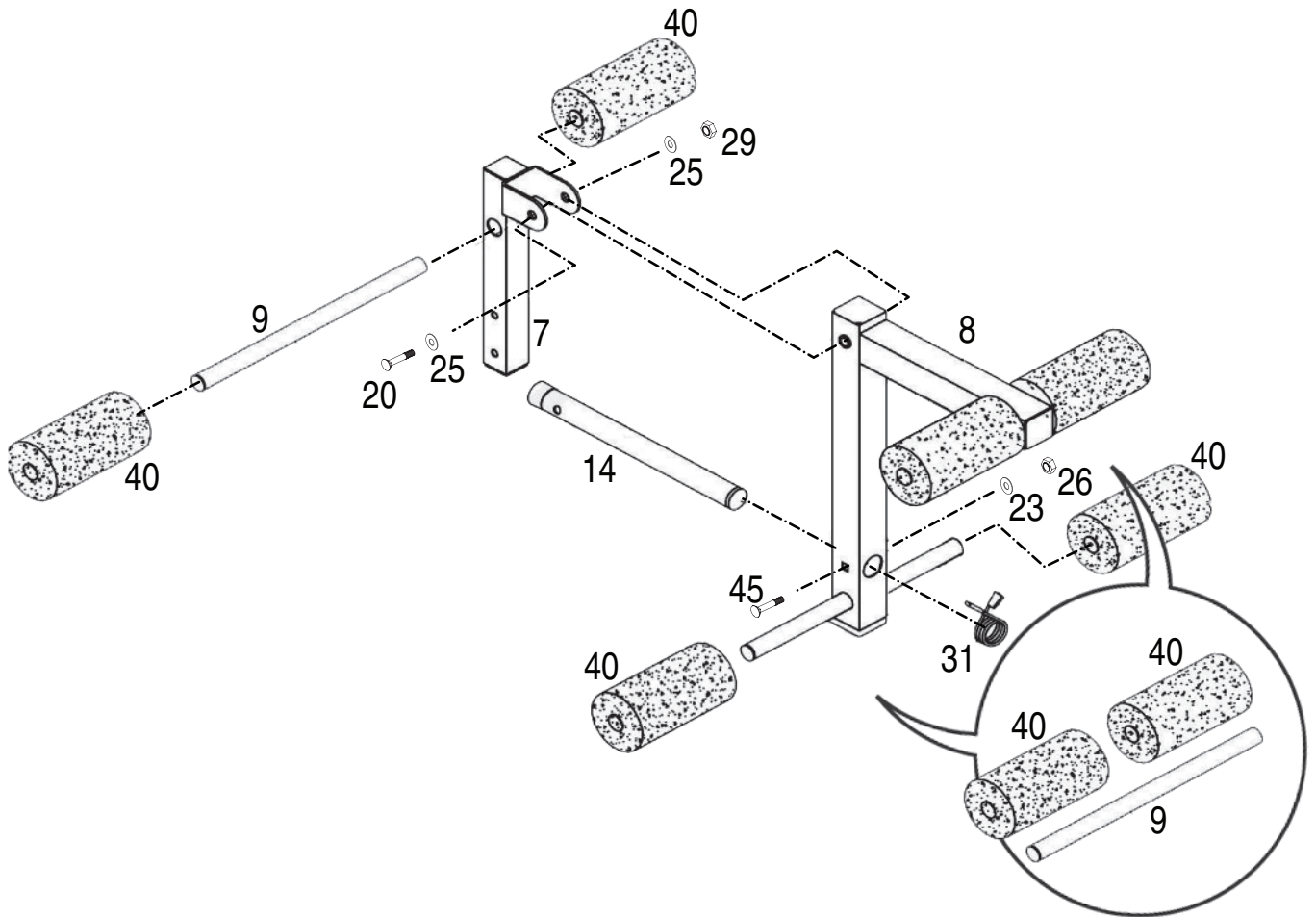

ASSEMBLY STEPS

STEP 9

- Fit **Leg Extension Support** (7) into the leg extension on upright to any one of 3 position and lock in position using the M8 **Locking Knob** (27).

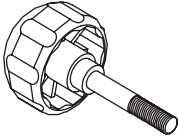
No.	Description	Q'ty
WB40-27	 Locking Knob (M8)	1

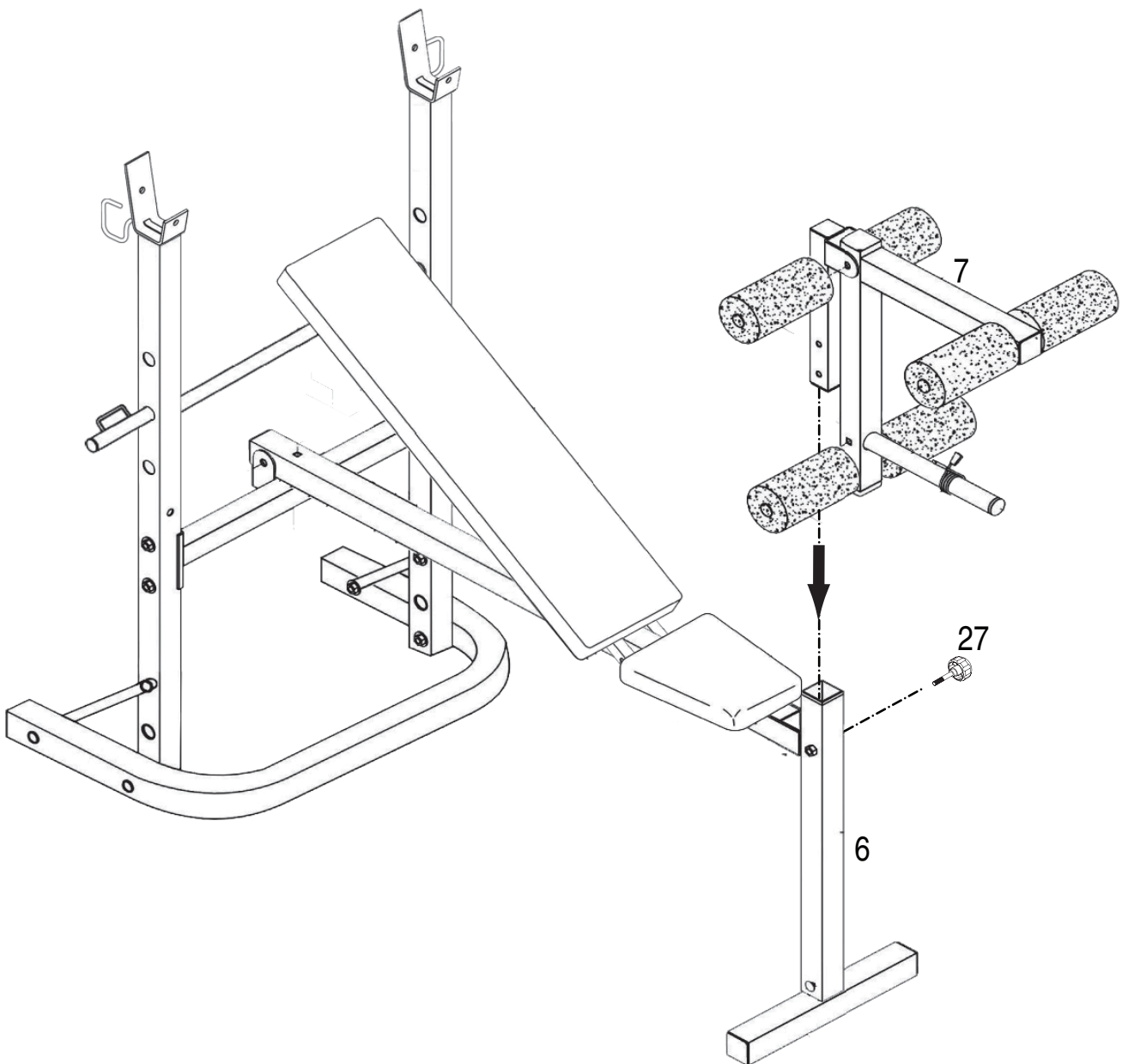

NOW GO BACK OVER AND TIGHTEN ALL NUTS AND BOLTS.

ASSEMBLY STEPS (FOLDING THE BENCH FOR STORAGE)

- Before folding up the **Main Frame** (4), please remove **Backrest Adjustment Rod** (10). Re-insert **Backrest Adjustment Rod** (10) after **Main Frame** (4) is folded to keep it in place.
- Unscrewing the M8 **Locking Knob** (Male) (27) then remove the **Leg Extension** (7). Place this assembly to one side.
- Unscrew the rear M8 **Locking Knob** (Female) (28) and remove the M8x90mm **Carriage Bolt** (19), M8 **Flat Washes** (23) and M8 **Spring Washes** (24).
- Lift up the **Main Frame** (4) to upright position.

Please do not trap your fingers in any moving parts.

- Unscrew the front M8 **Locking Knob** (Female) (28) and remove the M8x50mm **Carriage Bolt** (18), M8 **Flat Washer** (23), and M8 **Spring Washer** (24) then fold down the **Front Upright** (6) assembly.

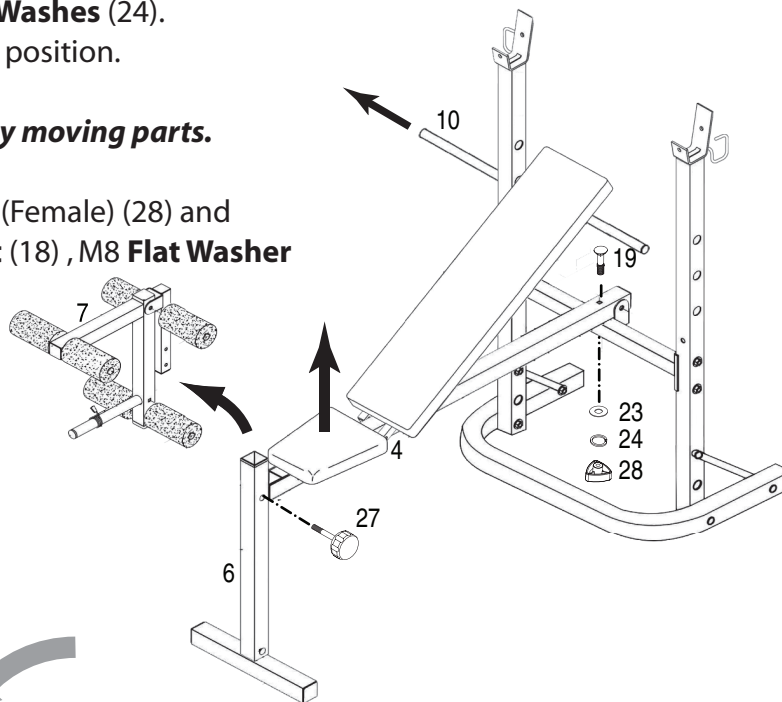

- Please set the **Leg Extension** (7) and both **bolt set** (23, 24, 28 and 19, 23, 24, 28) aside, do not lose them.

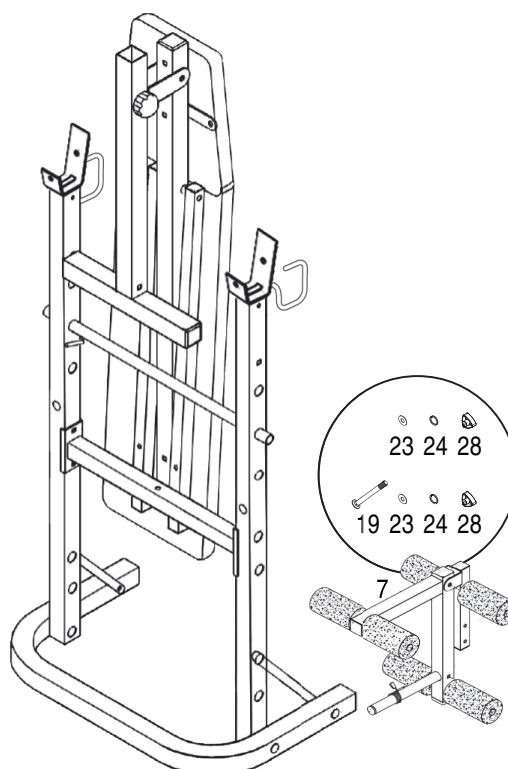
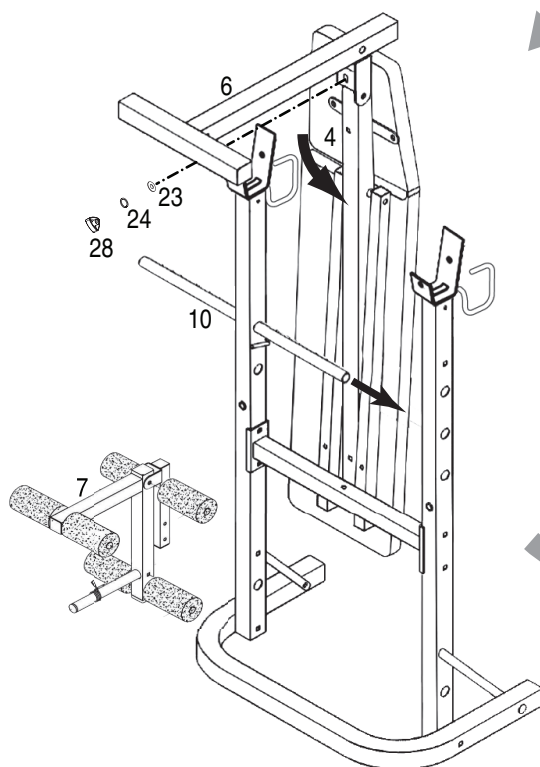

CAUTION

Please ensure that the Bench is securely stored in either an upright or full flat position away from children.

EXPLODED DRAWING

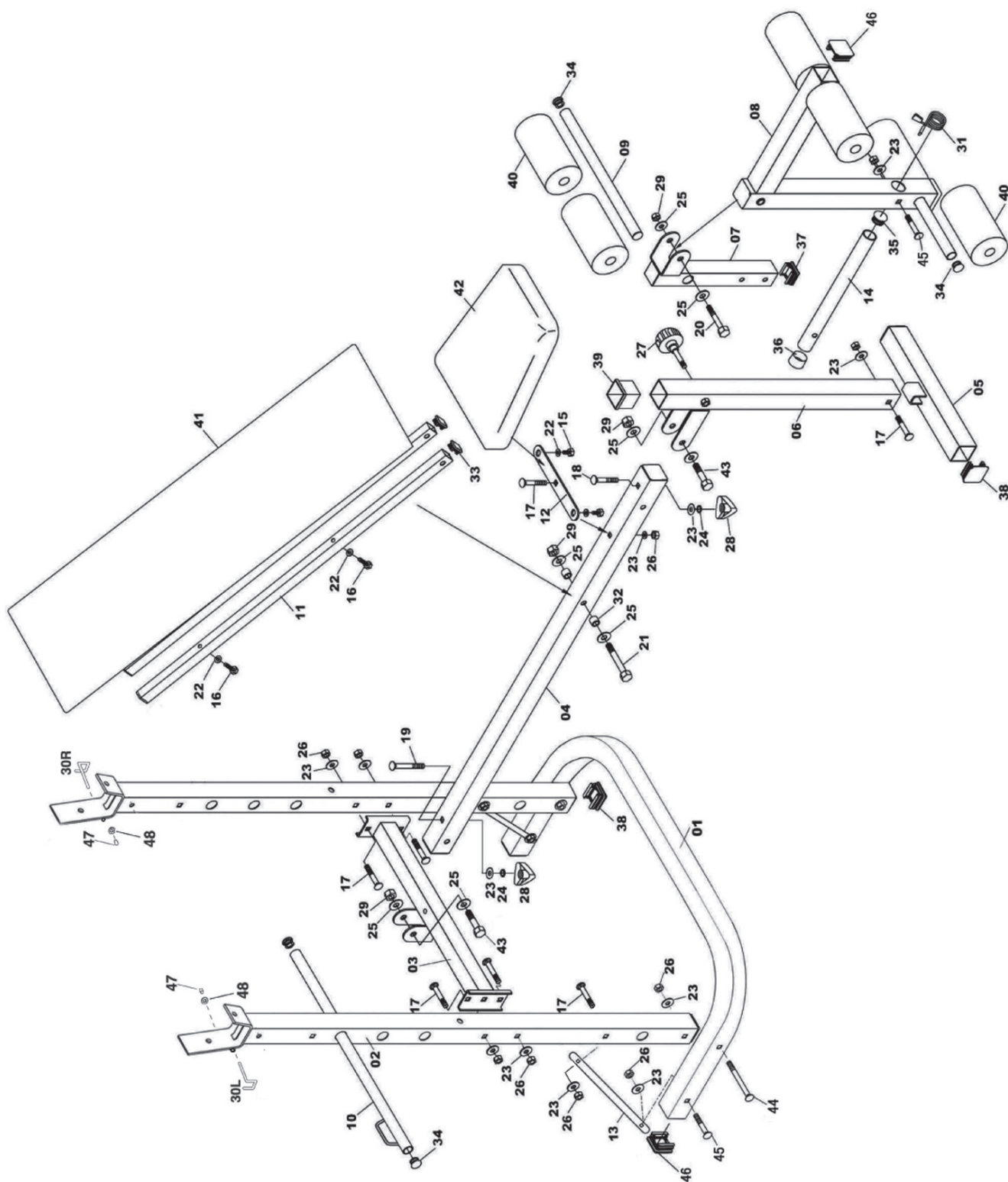

PARTS LIST

No.	Description	Qty	No.	Description	Qty
WB40-01	Rear Stabilizer	1	WB40-26	Nylon Locknut (M8)	13
WB40-02	Upright	2	WB40-27	Locking Knob (Male M8)	1
WB40-03	Cross Support	1	WB40-28	Locking Knob (Female M8)	2
WB40-04	Mainframe	1	WB40-29	Nylon Locknut (M10)	4
WB40-05	Front Stabilizer	1	WB40-30L	Safety Hook (L)	1
WB40-06	Leg Extension Upright	1	WB40-30R	Safety Hook (R)	1
WB40-07	Leg Extension Support	1	WB40-31	Spring Collar	1
WB40-08	Leg Extension	1	WB40-32	Backrest Support Bushing	2
WB40-09	Foam Roller Post	3	WB40-33	Square End Cap (25mm)	4
WB40-10	Backrest Adjustment Rod	1	WB40-34	Round End Cap (ø19mm)	8
WB40-11	Backrest Support	2	WB40-35	Round End Cap (ø25mm)	1
WB40-12	Seat Bracket	1	WB40-36	Round End Over Cap (ø25mm)	1
WB40-13	Stabilizer Bracket	2	WB40-37	Square End Cap (32mm)	2
WB40-14	Weight Disc Post	1	WB40-38	Square End Cap (38mm)	6
WB40-15	Bolt (M6 x 14mm)	2	WB40-39	Square Internal Bushing (38mm)	1
WB40-16	Bolt (M6 x 40mm)	4	WB40-40	Foam Roller	6
WB40-17	Carriage Bolt (M8 x 50mm)	8	WB40-41	Backrest	1
WB40-18	Carriage Bolt (M8 x 55mm)	1	WB40-42	Seat	1
WB40-19	Carriage Bolt (M8 x 90mm)	1	WB40-43	Hex Bolt (M10 x 55mm)	2
WB40-20	Hex Bolt (M10 x 60mm)	1	WB40-44	Carriage Bolt (M8 x 85mm)	2
WB40-21	Hex Bolt (M10 x 130mm)	1	WB40-45	Carriage Bolt (M8 x 45mm)	3
WB40-22	Flat Washer (M6)	6	WB40-46	Square End Cap (33.4mm)	5
WB40-23	Flat Washer (M8)	15	WB40-47	Locknut (M6)	2
WB40-24	Spring Washer (M8)	2	WB40-48	Washer (M6)	2
WB40-25	Flat Washer (M10)	8	WB40-49	Tool	2

IMPLIED WARRANTY

The importer of this machine assures that this device is manufactured with high quality materials.

The prerequisite for the implied warranty is the proper setup in accordance with the operating instructions. Improper use and/or incorrect transportation can void the warranty.

The implied warranty is valid for **1 year**, beginning from the date of purchase. For eventual defects please contact the dealer of this product within the guarantee period .

The warranty applies to the following parts
(as far as included in the scope of delivery):

Frame, Cable, Electronic Devices, Wheels, Pedals

The guarantee does not cover:

- Damage effected by outer force
- Intervention by unauthorized parties
- Incorrect handling of the product
- Non-compliance of the operating instructions

Wear parts and expendable parts are also not covered.
The device is only intended for home use. The warranty does not apply to commercial use of any kind.

Manufactured by:
Gymstick International Oy Ratakartijankatu 11
15170 Lahti, FINLAND